



The SYNTAX® SSX series, designed for professional lighting applications, and perfectly compatible with standard 19 pin Socapex (419 series), is extremely robust being of a machined aluminium alloy, thick wall construction with a hard black anodized finish or black painted finish. The insert stack is neoprene rubber, thereby allowing removable contacts in crimp or solder version. The unit is completely watertight to IP67 when mated.

Electrical safety and compliance is guaranteed through shells which are internally insulated, to prevent electric shock and "first make last break" ground contacts. Grounding rings allow bussing of the ground contacts. Locking ring and backshell design for easy handling.

- Compliant cRU US E 302043
- Ingress protection: IP67-IEC 529 norms
- Salt atmosphere resistance: 96 h IEC 68-21-11
- Operating temperature: -55°C to +125°C
- Shell material: aluminium alloy, machined
- Available: anodized finish or black painted finish
- Insert neoprene rubber
- Cable gland retention: PG 29 - PG 36

CONTACTS

The male and female are machined by high conductive copper alloy and are gold plated finish.

CRIMP

Voltage rating AC	Voltage rating DC	Max current	Rated current	Potential drop	Dielectric Strength	
					Test voltage	Min. Flashover
700 V	500 V	41 Amps	23 Amps	63 mV	2000 Vac RMS	2800 Vac RMS



MALE



FEMALE

SOLDER

Voltage rating AC	Voltage rating DC	Max current	Rated current	Potential drop	Dielectric Strength	
					Test voltage	Min. Flashover
700 V	500 V	41 Amps	23 Amps	63 mV	2000 Vac RMS	2800 Vac RMS



MALE



FEMALE

GROUND CONNECTION



Ground first connection

In compliance to electrical safety the 7 central pins are moved forward and allows "first make last break" ground contact.



Common ground (OPTIONAL) Part N.: SSXCMGR

Two disks are easily fitted to the central ring of six contacts, thereby creating a common ground ring.



**Shell grounding
SPECIAL VERSION** pon request
Body shell grounding contact guarantee full safety.

SSX 19 PIN STANDARD SERIES

Compliant
C  US

SYNTAX CONNECTORS

SSX19MV



Inline male

SSX19FV



Inline female

SSX19MP



Panel male

SSX19FP



Panel female

SSX SERIES COMPATIBLE WITH STANDARD 19 PIN SOCAPEX (419 series)



Safety insulating tube

ERGONOMIC COUPLING GRIP



CABLE GLANDS FOR SSX SERIES

These glands provide positive strain relief and water tight sealing. Technical characteristics:

- Approvals: UL E146370 - CSA LR-50370 - VDE 57086 - SEV 100989
- Protection: Up to 70 PSI
- Material: Polyamide - flame retardant, self-extinguishing nylon with neoprene bushing
- Rated Temperature: -20°C to 80°C (UL), up to +100°C Max
- Seal IP 68 (International Protection - highest grade), comparable to NEMA 6 classification
 - First digit (0-6): Dust Protection
 - Second digit (0-8): Water Protection
- Resistant to Salt water, weak acids, weak alkalis, alcohol, ester, ketones, ether, benzene, gas, mineral oil, animal and vegetable oils, gasoline, oil, grease, and common solvents

PG 29

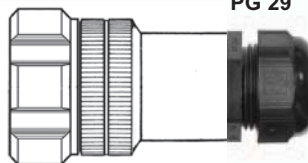

PG 36

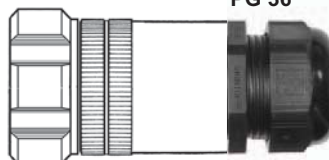

OVERALL SIZE & CUT-OUT DIMENSIONS

PANEL FEMALE			
A	ØB	C	D
57	47,8	41	37,5

PANEL MALE			
A	B	C	D
57	41	60	38

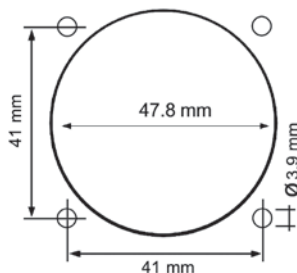
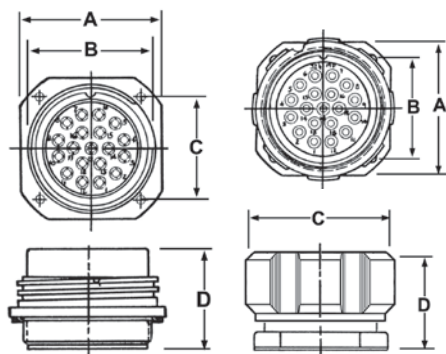

INLINE MALE	
A	ØB
120	64

INLINE FEMALE		
A	ØB	ØC
120	46	52

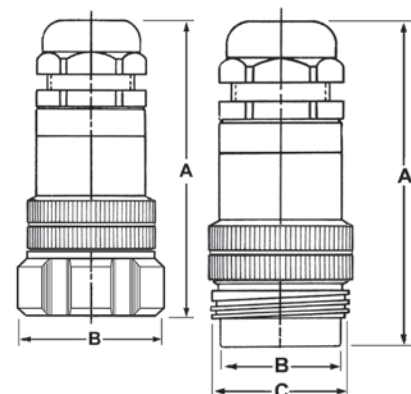

SSX 19 PIN STANDARD CABLES

SP19M6FBL-010 (1 mt) - 015 (1,5 mt) - 020 (2 mt)



SPIDER SPLITTER

Assembled list:

- n.1 P/N : SSX19MVYGCMS - (Syntax SSX19 male)
- n.6 P/N : Y213-6X - (CEE17 16A 230V 3P female)
- mt P/N : 7ZF0325 - Syntax Cable 3 x 2.5 mm²

SP6M19FBL-010 (1 mt) - 015 (1,5 mt) - 020 (2 mt)



SPIDER SPLITTER

Assembled list:

- n.1 P/N : SSX19FV-GCMS - (Syntax SSX19 female)
- n.6 P/N : Y013-6X - (CEE17 16A 230V 3P male)
- mt P/N : 7ZF0325 - Syntax Cable 3 x 2.5 mm²

EC19P25-L...



Assembled list:

- 1 x P/N SSX19MVYGCP5N - (Syntax SSX19 male)
- 1 x P/N SSX19FV-GCMS - (Syntax SSX19 female)
- mt P/N 7ZF1925 - Syntax Cable 19x2.5 mm²

- EC19P25-L10 10 mt cable lenght
- EC19P25-L20 20 mt cable lenght
- EC19P25-L... cable lenght upon request

Y213-6X



Inline female black color splashproof IP44. Easy assembling by quick lock. Water-proof cable gland no unscrewing system. 220V 16A 2p + T

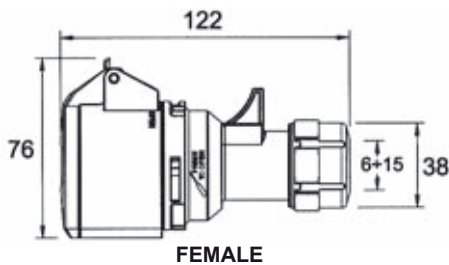

Y013-6X



Inline male black color splashproof IP44. Easy assembling by quick lock. Water-proof cable gland no unscrewing system. 220V 16A 2p + T

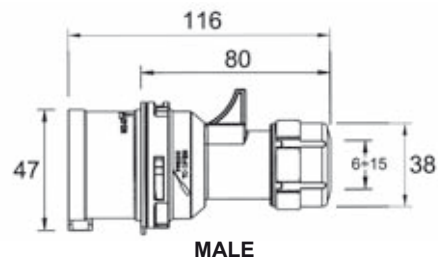

SETTING UP BY NO TOOLS



DISASSEMBLING JUST A SCREWDRIVER



