



**SVK**  
**& SVS**  
**AUDIO**  
**SERIES**  
**MULTIPIN**  
**CONNECTORS**

***syntax***  
**no compromise**

## INLINE FEMALE



The new **SYNTAX® SVK** audio series has been conceived and manufactured to set a higher standard for studio applications. Its IP67 waterproof rating makes it perfectly suitable also for outdoor applications. **SVS** Slim High-Density series is also available (72 and 101 pin configurations). **SVK** audio and **SVS** Slim High Density series are compliant with military standard Mil C 5015 & VG 95234. Compared to our previous standard audio series, the new SVK has been enhanced to achieve a higher level of robustness and durability.

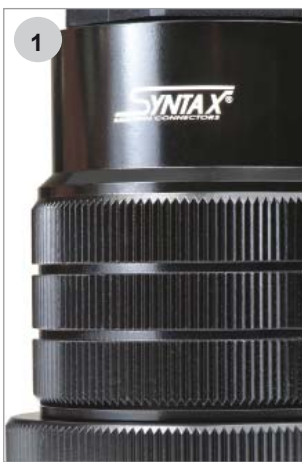

Special aluminium alloy shell with high-resistance black finish.

Pic. 1 - Marked knurling on the whole circumference of locking-ring for optimal grip and easy coupling. An audible click indicates that locking is complete.

Pic. 2 - Thick wall construction locking-ring for greater resistance to all possible forms of abuse.

Pic. 3 - The aluminium housing for the neoprene insert is flush with the edge of locking-ring, so to avoid ovalization due to accidental blows.

Pic. 4 - Extra wide backshell for easier wiring.

Increased size of Coupling roller pins on locking-ring for more durability.

## INLINE MALE



Many of its features have been borrowed from the bigger SHD Roadline series, such as a thicker locking ring with deeper knurling for maximum ease of coupling and a thicker backshell. The new aluminium locking ring also features coupling roller pins and, just like on the SHD series, the locking ring is designed in such a way to prevent possible ovalization of the insert due to accidental blows. Protective dust caps are available. They are provided with a special high-resistance cable lacing made up of seven stainless strands, covered by an anti-abrasion Teflon black tube.

**SVK** audio is available in 13, 19, 25, 37, 54, 85, 100 and 150 pin configurations.

**SVS** Slim High-Density series is available in 72 and 101 pin configurations.

## DUST CAP FOR IP67 WHEN MATED

Version for  
female  
connector



Version for  
male  
connector



# SVK AUDIO 13 - 19 - 25 - 37 - 54 - 72 - 85 - 100 - 101 - 150 PIN & SVS



**PANEL FEMALE**



**PANEL MALE**

## CONTACTS

### CRIMP CONTACTS TYPES AND PART N.

Size	Connector	Plating	Part N.	Gender	Part N.	Gender
16	13/19/25/37/54/85 pin	Silver	SVKP16SFC	Female	SVKP16SMC	Male
		Gold	SVKP16GFC	Female	SVKP16GMC	Male
18	100/150 pin	Gold	SVKP18GFC	Female	SVKP18GMC	Male
20	72/101 pin	Gold	SVKP20GFC	Female	SVKP20GMC	Male

### SOLDER CONTACTS TYPES AND PART N.

Size	Connector	Plating	Part N.	Gender	Part N.	Gender
16	13/19/25/37/54/85 pin	Gold	SVKP16GFS	Female	SVKP16GMS	Male

### CONTACTS RATING

Size	Max Current	Rated Current	Max Voltage Drop	Wire section (mm <sup>2</sup> )	Wire section AWG
16	22 A	13 A	74 mv	1+1,5	18+16
18	10 A	7,5 A	83 mv	0,15+0,6	26+20
20	7,5 A	7,5 A	83 mv	0,15+0,3	26+22

### CONNECTORS RATING

Contacts number	Operating voltage		Test voltage	Min. Flashover
	Vdc	Vac	Vac	Vac
13/19/25/150 - 72/101	250	200	1000	1400
37/54/85/100	700	500	2000	2800

## OVERALL SIZE

## CUT-OUT DIMENSIONS

### PANEL FEMALE

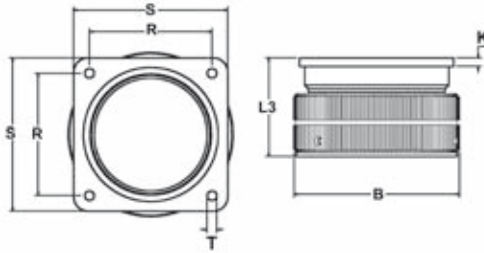

N° pin	shell size	BØ Max	L3	K	R	S	T
			Max	±0.2	±0.1	±0.3	H13
13 - 19	20	43.0	38.1	4	29.4	38.0	3.2
25	24	50.4	40.6	4	34.9	44.5	3.7
37-72	28	56.0	40.8	4	39.7	50.8	3.7
54-101	32	63.0	43.7	4	44.45	57.0	4.4
85-100-150	40	75.0	44.8	4	55.6	69.8	4.4

### PANEL MALE

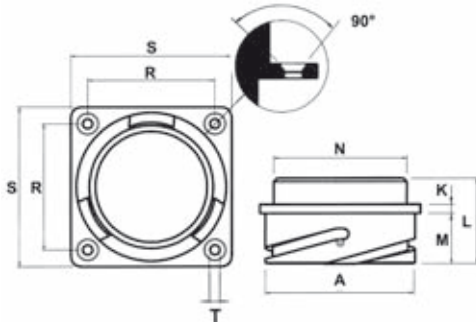

N° pin	shell size	AØ	K	L	M	ØN	R	S	T
		+0/-0.15	±0.2	±0.3	±0.4/-0	Max	±0.1	±0.3	H13
13 - 19	20	34.2	4	34.5	19	31.75	29.4	38.1	3.2
25	24	40.9	4	35.7	20.6	35.3	34.9	44.5	3.7
37-72	28	46.7	4	35.7	20.6	41.4	39.7	50.8	3.7
54-101	32	53.4	4	37.3	22.2	47.8	44.5	57	4.3
85-100-150	40	65.5	4	37.3	22.2	59	55.6	69.8	4.3

### INLINE FEMALE

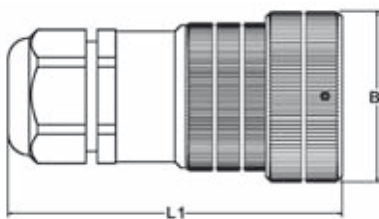

N° pin	shell size	BØ Max	L1 Max	Cable clamp Metric	Ø cable Min.-Max.
13 - 19	20	43.0	103	M 20	6 - 14
25	24	50.4	108	M 25	6 - 18
37-72	28	56.0	116	M 32	7 - 25
54-101	32	63.0	121	M 32	7 - 25
85 - 100 - 150	40	75.0	147	M 40	15 - 32

### INLINE MALE

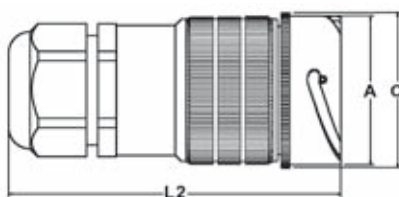

N° pin	shell size	AØ Max	ØC	L2 Max	Cable clamp Metric	Ø cable Min.-Max.
		+0/-0.15	Max			
13 - 19	20	40.0	43	102	M 20	6 - 14
25	24	40.9	44	109	M 25	6 - 18
37-72	28	46.7	50	116	M 32	7 - 25
54-101	32	53.4	56	122	M 32	7 - 25
85 - 100 - 150	40	65.5	69	147	M 40	15 - 32

### 13/19 pin

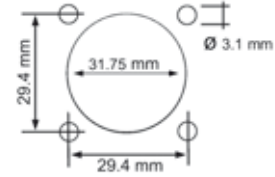

### 25 pin

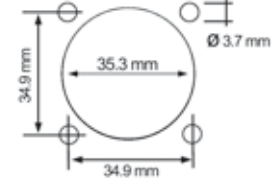

### 37/72 pin

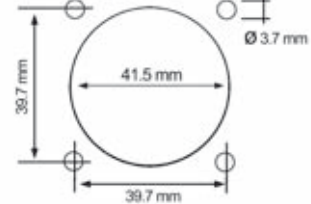

### 54/101 pin

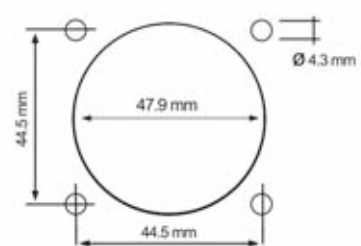

### 85/100/150 pin

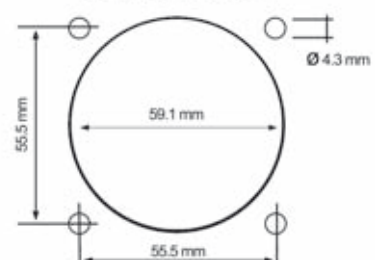

# INSERT LAYOUTS AND WIRING LIST

## FRONT VIEW OF MALE INSERT

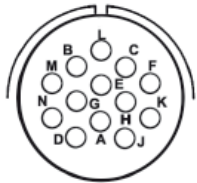

13 pin / size 20

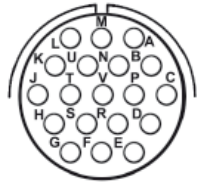

19 pin / size 20

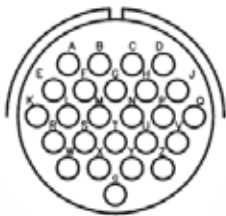

25 pin / size 24

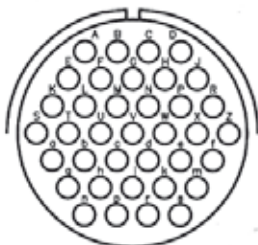

37 pin / size 28

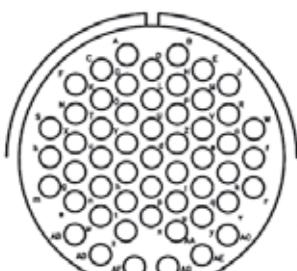

54 pin / size 32

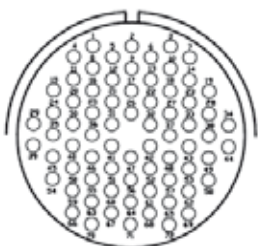

72 pin / size 28

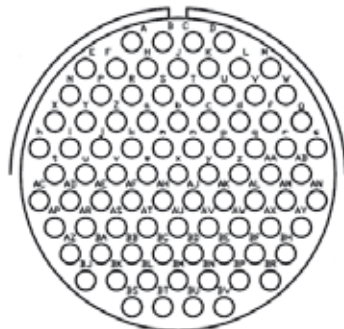

85 pin / size 40

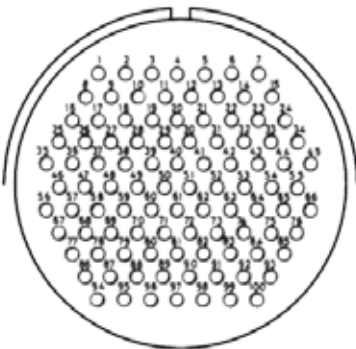

100 pin / size 40

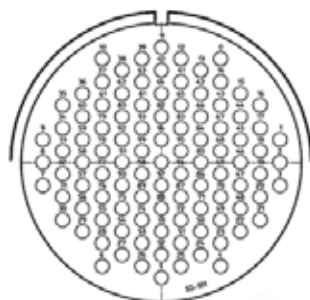

101 pin / size 32

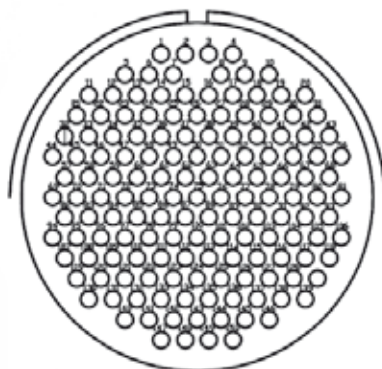

150 pin / size 40

13 pin - 4 channels			
Ch	Hot	Cold	Gnd
No.	+	-	⏏
1	M	B	L
2	N	G	E
3	D	A	H
4	J	K	F

19 pin - 6 channels			
Ch	Hot	Cold	Gnd
No.	+	-	⏏
1	A	M	L
2	C	P	B
3	N	U	V
4	T	J	K
5	D	R	E
6	F	G	S

25 pin - 8 channels			
Ch	Hot	Cold	Gnd
No.	+	-	⏏
1	A	E	F
2	G	C	B
3	D	H	J
4	M	L	K
5	Q	P	N
6	W	S	R
7	T	X	Y
8	Z	V	U

37 pin - 12 channels			
Ch	Hot	Cold	Gnd
No.	+	-	⏏
1	E	F	A
2	B	C	G
3	H	J	D
4	S	T	K
5	L	M	U
6	V	W	N
7	P	R	X
8	a	b	g
9	c	d	j
10	e	f	m
11	n	p	h
12	r	s	k

54 pin - 16 channels			
Ch	Hot	Cold	Gnd
No.	+	-	⏏
1	W	f	r
2	J	R	a
3	k	v	AC
4	E	M	V
5	e	q	y
6	B	H	P
7	Z	j	u
8	D	L	U
9	d	p	x
10	A	G	O
11	Y	h	t
12	C	K	T
13	c	n	w
14	F	N	X
15	g	s	AB
16	S	b	m

85 pin - 28 channels			
Ch	Hot	Cold	Gnd
No.	+	-	⏏
1	A	B	C
2	E	F	H
3	J	K	L
4	N	P	R
5	S	T	U
6	X	Y	Z
7	a	b	c
8	d	f	g
9	h	i	j
10	k	m	n
11	p	q	r
12	t	u	v
13	w	x	y
14	z	AA	AB
15	AC	AD	AE
16	AF	AH	AJ
17	AK	AL	AM
18	AP	AR	AS
19	AT	AU	AV
20	AW	AX	AY
21	AZ	BA	BB
22	BC	BD	BE
23	BJ	BK	BL
24	BM	BN	BP
25	BS	BT	BU
26	BV	BR	BF
27	BH	AN	s
28	W	M	D

72 pin - 24 channels			
Ch	Hot	Cold	Gnd
No.	+	-	⏏
1	3	2	1
2	5	6	7
3	9	8	4
4	13	14	10
5	15	11	12
6	18	17	16
7	22	23	19
8	24	20	21
9	27	26	25
10	33	34	28
11	30	31	32
12	36	35	29
13	44	43	37
14	41	42	43
15	45	39	40
16	48	47	46
17	52	53	49
18	54	50	51
19	57	56	55
20	61	62	58
21	63	59	60
22	69	65	64
23	66	67	68
24	72	71	70

100 pin - 32 channels			
Ch	Hot	Cold	Gnd
No.	+	-	⏏
1	1	2	3
2	4	5	6
3	7	8	9
4	10	11	12
5	13	14	15
6	16	17	18
7	19	20	21
8	22	23	24
9	25	26	27
10	28	29	30
11	31	32	33
12	34	35	36
13	37	38	39
14	40	41	42
15	43	44	45
16	46	47	48
17	49	50	51
18	52	53	54
19	55	56	57
20	58	59	60
21	61	62	63
22	64	65	66
23	67	68	69
24	70	71	72
25	73	74	75
26	76	77	78
27	79	80	81
28	82	83	84
29	85	86	87
30	88	89	90
31	91	92	93
32	94	95	96
33	97	98	99

101 pin - 32 channels			
Ch	Hot	Cold	Gnd
No.	+	-	⏏
1	3	2	1
2	9	8	7
3	12	11	10
4	15	14	13
5	18	17	16
6	21	20	19
7	24	23	22
8	27	26	25
9	30	29	28
10	33	32	31
11	36	35	34
12	39	38	37
13	42	41	40
14	45	44	43
15	48	47	46
16	51	50	49
17	54	53	52
18	57	56	55
19	60	59	58
20	63	62	61
21	66	65	64
22	69	68	67
23	72	71	70
24	75	74	73
25	78	77	76
26	81	80	79
27	84	83	82
28	87	86	85
29	88	89	90
30	93	92	91
31	96	95	94
32	99	98	97

150 pin - 48 channels			
Ch	Hot	Cold	Gnd
No.	+	-	⏏
1	1	2	3
2	5	6	7
3	8	9	10
4	11	12	13
5	14	15	16
6	17	18	19
7	21	22	23
8	24	25	26
9	27	28	29
10	20	30	31
11	32	33	34
12	35	36	37
13	38	39	40
14	41	42	43
15	44	45	46
16	47	48	49
17	50	51	52
18	53	54	55
19	57	58	59
20	60	61	62
21	63	64	65
22	66	67	68
23	69	70	71
24	72	73	74
25	75	76	77
26	78	79	80
27	82	83	84
28	85	86	87
29	88	89	90
30	91	92	93
31	94	95	96
32	97	98	99
33	100	101	102
34	103	104	105
35	56	81	106
36	107	108	109
37	110	111	112
38	113	114	115
39	116	117	118
40	119	120	121
41	122	123	124
42	125	126	127
43	139	128	129
44	130	131	132
45	133	134	135
46	136	137	138
47	140	141	142
48	143	144	145

# PART NUMBER EXPLANATION

Part N.

EXAMPLE Part N. **SVK 150 F V R G S MP N**

CONNECTOR SERIES	
SVK = (13 - 19 - 25 - 37 - 54 - 85 - 100 - 150 pin) Back shell: standard. Locking ring: ergonomic and rubber coated	<b>SVK</b>
SVS = (72 - 101 PIN) slim series, high density. Back shell: standard. Locking ring: ergonomic and rubber coated	<b>SVS</b>

CONTACTS NUMBER	
013 - 019 - 025 - 037 - 054 - 072 - 085 - 100 - 101 - 150	...

CONTACT TYPE	
M = male	<b>M</b>
F = female	<b>F</b>

CONNECTOR TYPE	
V = inline	<b>V</b>
P = panel	<b>P</b>

COUPLING TERMINATION	
- = with ramps	<b>-</b>
H = ergonomic locking ring with improved thickness and stronger roller pins	<b>H</b>
R = rubber coated locking ring	<b>R</b>

CONTACT PLATING TYPE	
S = silver (13 - 19 - 25 - 37 - 54 - 85 pin)	<b>S</b>
G = gold (13 - 19 - 25 - 37 - 54 - 72 - 85 - 100 - 101 - 150 pin)	<b>G</b>
N = no contact	<b>N</b>

CONTACT TERMINATION	
C = crimp	<b>C</b>
S = solder	<b>S</b>
P = pcb	<b>P</b>
N = no contact	<b>N</b>

CABLE CLAMP RANGE - METRIC				
Thread Size	Clamping Range (mm)	SVK (pins)	SVS (pins)	
M 20 x 1.5	6 - 12	13 - 19		<b>MH</b>
M 20 x 1.5	10 - 14	13 - 19		<b>MI</b>
M 25 x 1.5	6 - 13	25		<b>MJ</b>
M 25 x 1.5	13 - 18	25		<b>ML</b>
M 32 x 1.5	7 - 15	37 - 54	72 - 101	<b>MN</b>
M 32 x 1.5	11 - 21	37 - 54	72 - 101	<b>MM</b>
M 32 x 1.5	18 - 25	37 - 54	72 - 101	<b>MO</b>
M 40 x 1.5	15 - 23	85 - 100 - 150		<b>MQ</b>
M 40 x 1.5	19 - 28	85 - 100 - 150		<b>MP</b>
M 40 x 1.5	22 - 32	85 - 100 - 150		<b>MR</b>

CABLE CLAMP TYPE	
N = normal	<b>N</b>
S = spiral flex	<b>S</b>
R = strain relief	<b>R</b>

SPECIAL VERSION (upon request)	
For example: T = inserted solder termination contacts	<b>T</b>

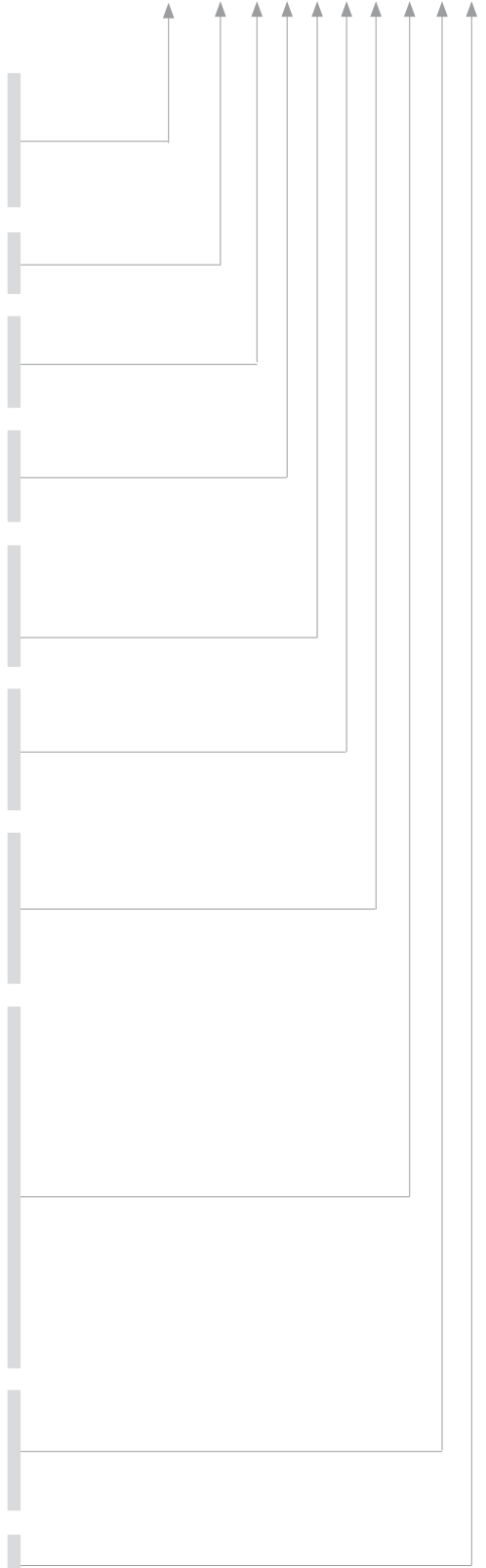

# VALENTINI

www.syntaxnet.it  
info@syntaxnet.it  
Tel. +39 0119594160  
Fax +39 0119594166  
via Asti 84/A  
10098 Rivoli  
(TO) - ITALY

**SYNTAX**<sup>®</sup>  
is a VALENTINI Trade Mark

